

KHX4000LLK2/1G

**1GB (512MB 64M x 64-Bit x 2 pcs.) PC4000
CL3 184-Pin DIMM Kit**

DESCRIPTION:

Kingston's KHX4000LLK2/1G is a kit of two 64M x 64-bit (512MB) PC4000 SDRAM (Synchronous DRAM) CL3 memory modules. Total kit capacity is 1GB (1024MB). The components on each module include eight 64M x 8-bit (16M x 8-bit x 4 Bank) DDR400 SDRAM in TSOP packages. Each module pair has been tested to run at DDR 500MHz low latency timing of 3-3-3-8-1T at 2.7V. The SPD is programmed to JEDEC standard latency 400Mhz timing of 3-3-3-8-1T at 2.6V. Each 184-pin DIMM uses gold contact fingers and requires +2.6V. The electrical and mechanical specifications are as follows:

FEATURES:

- ✓ Power supply : Vdd: 2.6V ± 0.1V, Vddq: 2.6V ± 0.1V
- ✓ Double-data-rate architecture; two data transfers per clock cycle
- ✓ Bidirectional data strobe(DQS)
- ✓ Differential clock inputs(CK and CK)
- ✓ DLL aligns DQ and DQS transition with CK transition
- ✓ Programmable Read latency 3 (clock)
- ✓ Programmable Burst length (2, 4, 8)
- ✓ Programmable Burst type (sequential & interleave)
- ✓ Timing Reference: 400MHz 3-3-3-8-1T at +2.6V / 500MHz 3-3-3-8-1T at +2.7V
- ✓ Edge aligned data output, center aligned data input
- ✓ Auto & Self refresh, 7.8us refresh interval (8K/64ms refresh)
- ✓ Serial presence detect with EEPROM
- ✓ High Performance Heat Spreader
- ✓ PCB : Height 1.250" (31.75mm), single sided component

PERFORMANCE:

- ✓ Clock Cycle Time (tCK) 5ns (min.) / 10ns (max.)
- ✓ Row Cycle Time (tRC) 55ns (min.)
- ✓ Refresh Row Cycle Time (tRFC) 70ns (min.)
- ✓ Row Active Time (tRAS) 40ns (min.) / 70,000ns (max.)
- ✓ Power 3.432 W (operating per module)
- ✓ UL Rating 94 V - 0
- ✓ Operating Temperature 0° C to 70° C
- ✓ Storage Temperature -55° C to +150° C

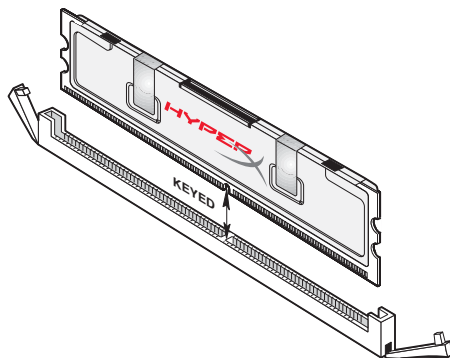

MODULE DIMENSIONS:

Units : Inches (Millimeters)

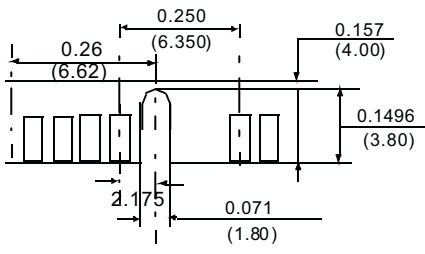
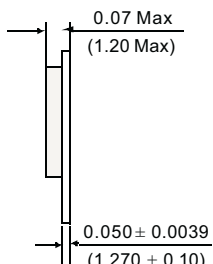
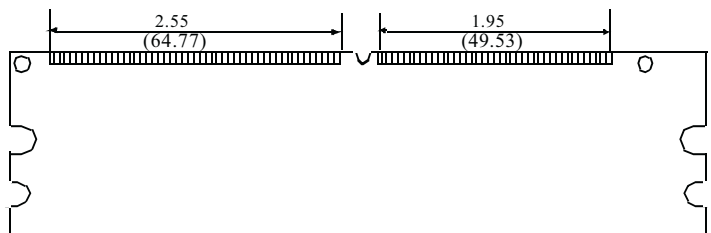
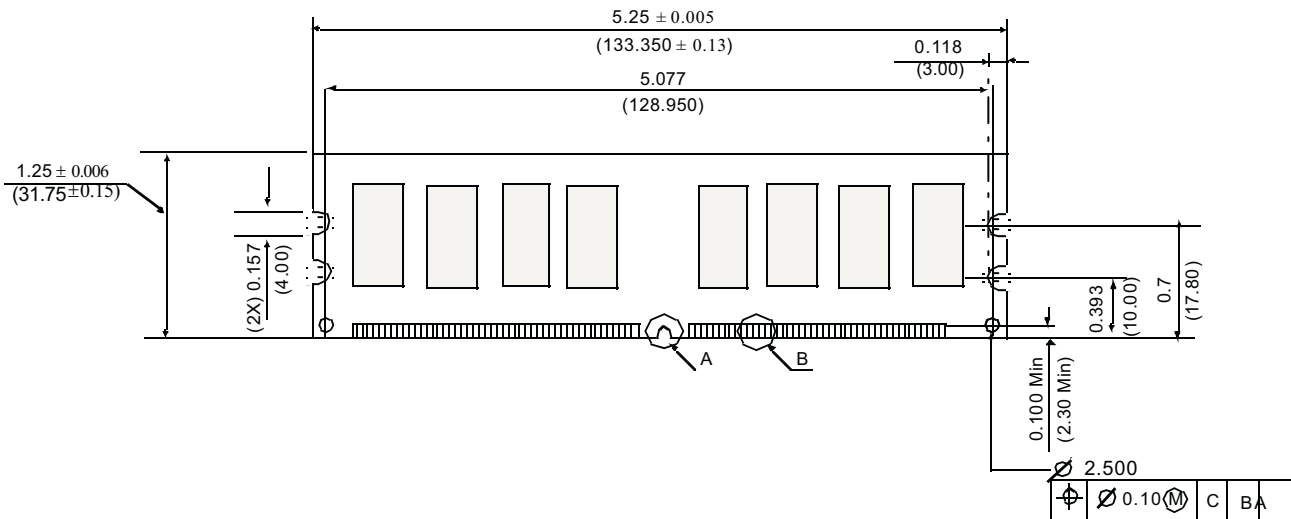

Detail A

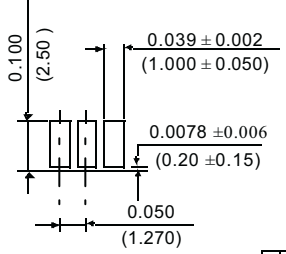

Detail B

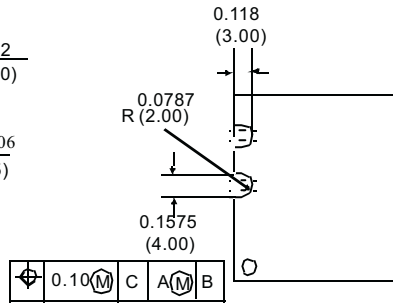

Tolerances : ± 0.005(.13) unless otherwise specified.

For more information, go to www.kingston.com

All Kingston products are tested to meet our published specifications. Some motherboards or system configurations may not operate at the published HyperX memory speeds and timing settings. Kingston does not recommend that any user attempt to run their computers faster than the published speed. Overclocking or modifying your system timing may result in damage to computer components.